

1.5

Classifying Polygons

Definitions

- **Polygon**

- **Convex Polygon**

- **Consecutive Vertices**

- **Consecutive Sides**

- **Consecutive Angles**

- **Perimeter**

Parts of Congruent Polygons

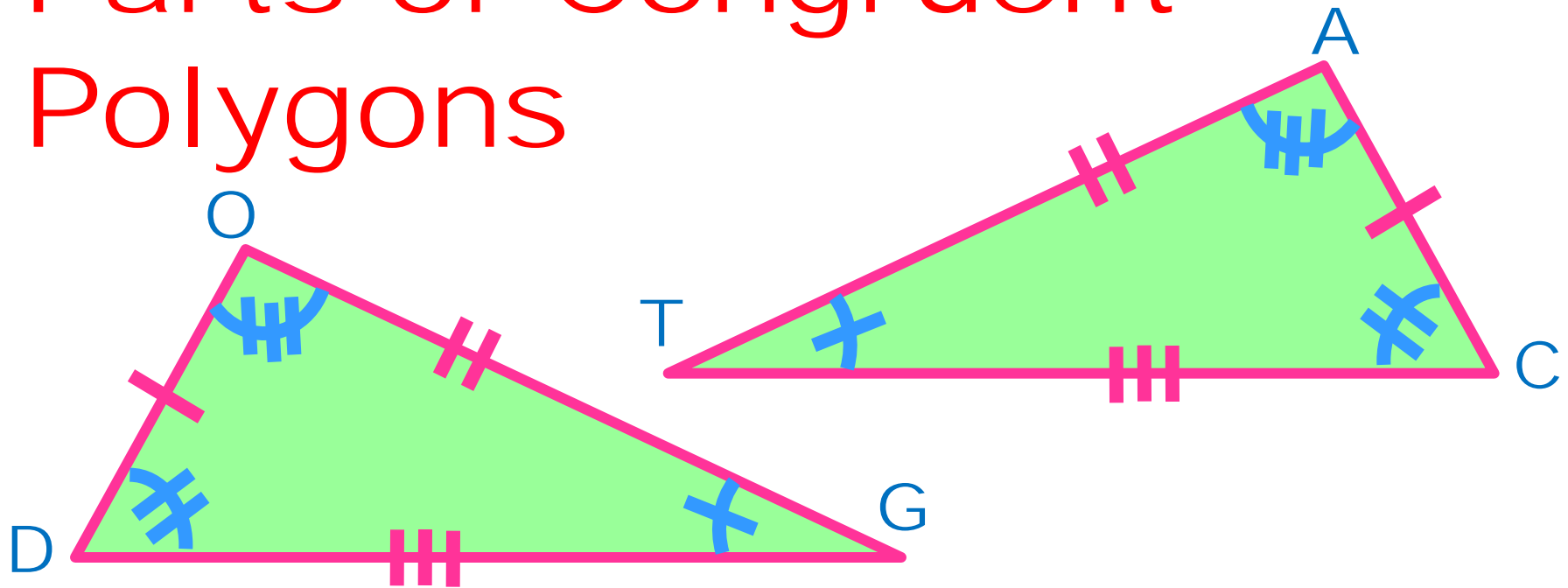

Congruent Polygons have the _____ . In addition, corresponding parts of these shapes are _____ .

Parts of Congruent Polygons

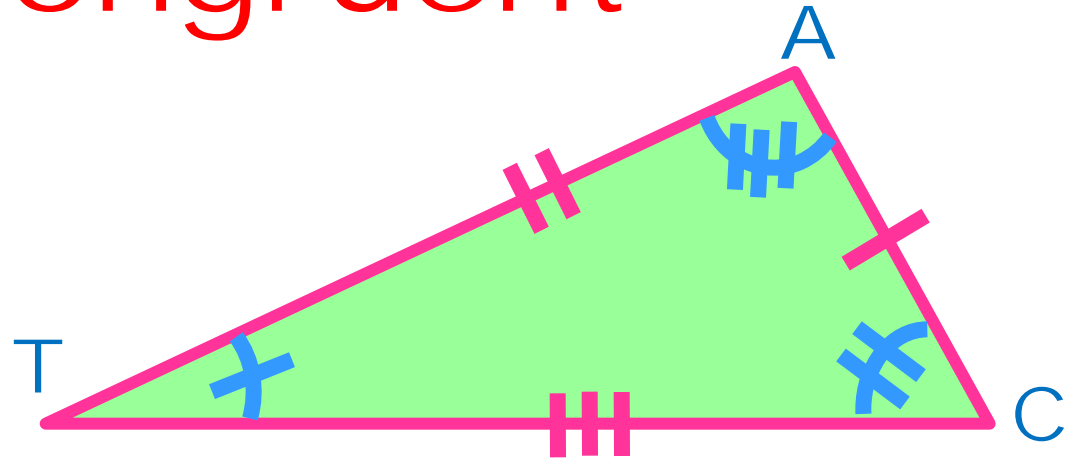
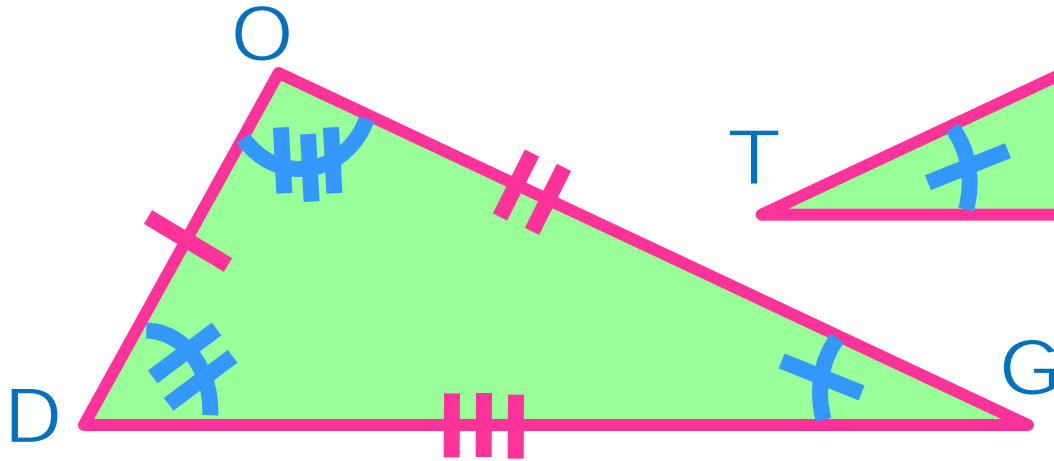

Naming Polygons

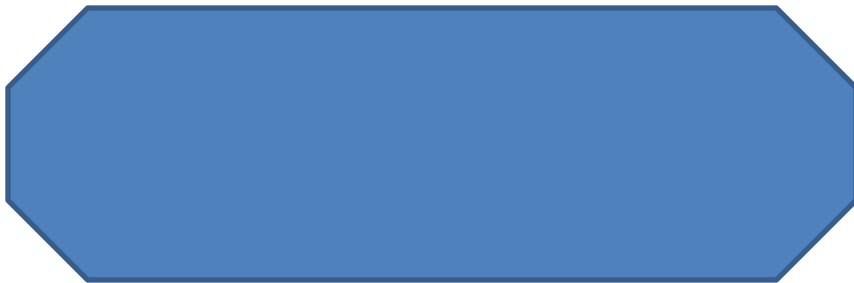
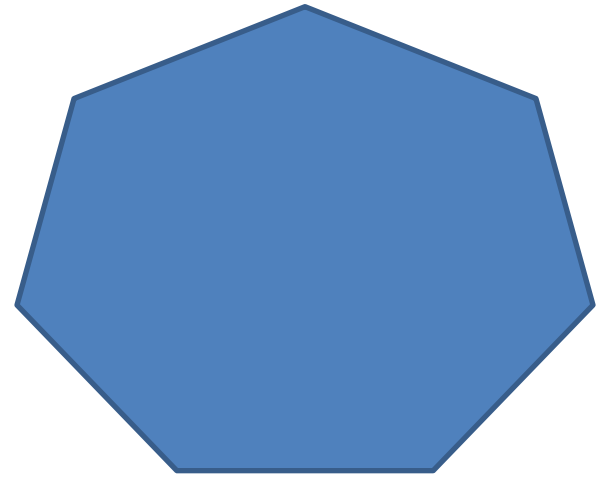

1. Define *diagonal of a polygon*.

Diagonals of polygons

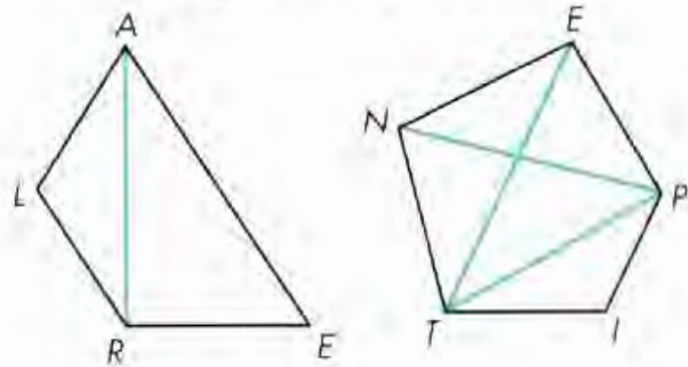

Segments AR , PN , TE , and PT are diagonals.

Not diagonals of polygons

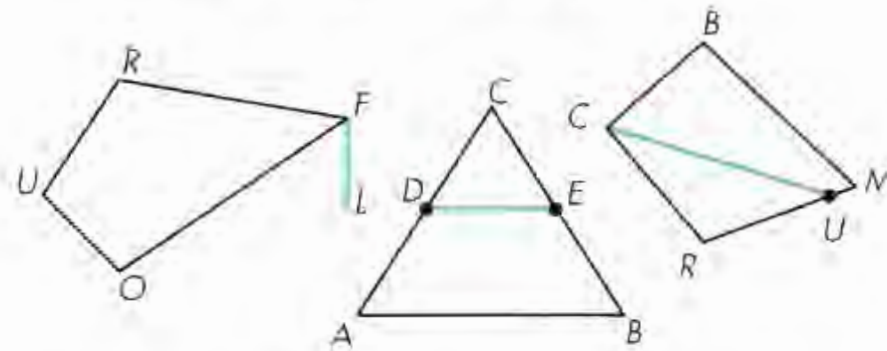

Segments FL , FO , CU , and DE are not diagonals.

2. Define *equilateral polygon*.

Equilateral polygons

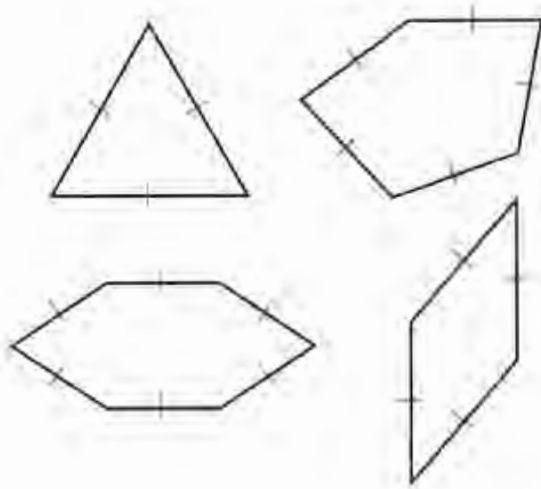

Not equilateral polygons

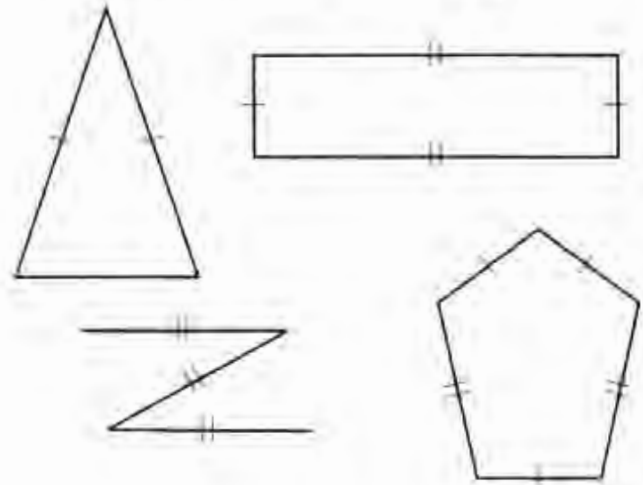

3. Define *equiangular polygon*.

Equiangular polygons

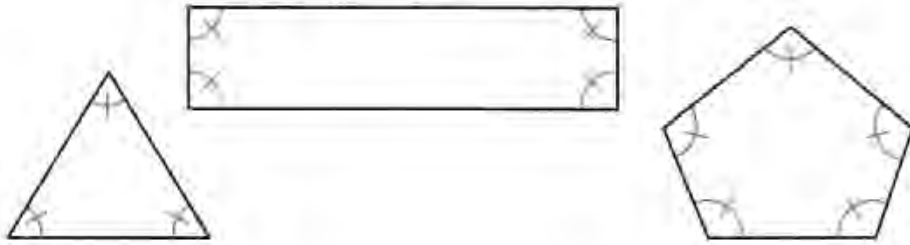

Not equiangular polygons

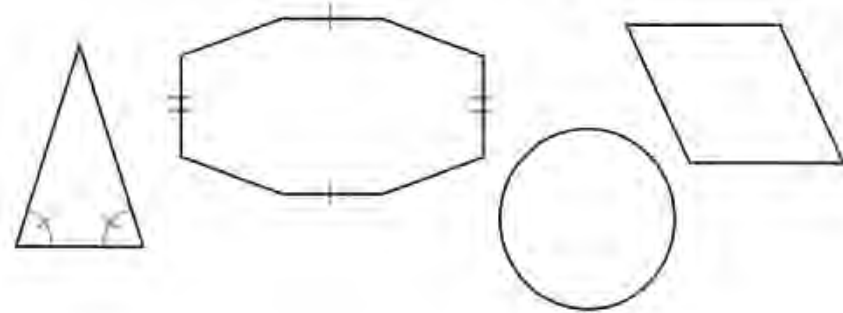

4.* Define *regular polygon*.

Regular polygons

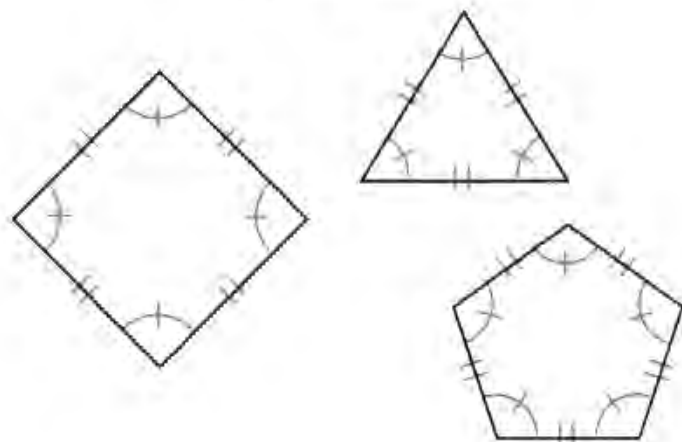

Not regular polygons

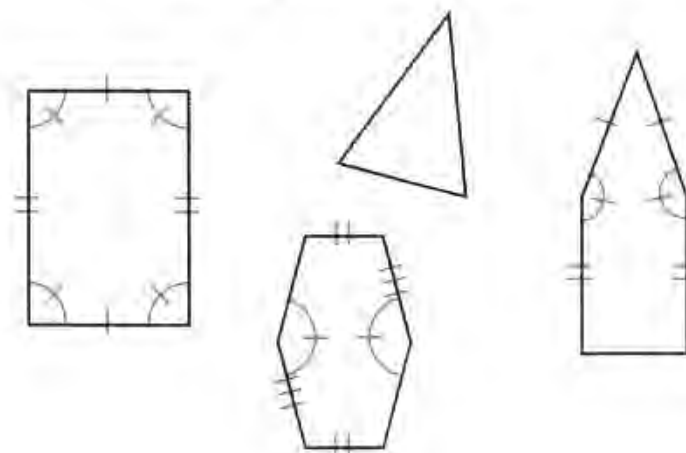

1.* Define *right triangle*.

Right triangles

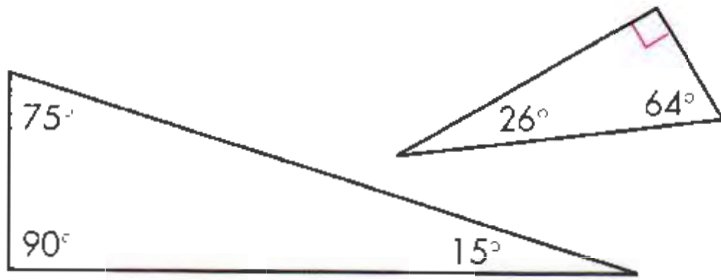

Not right triangles

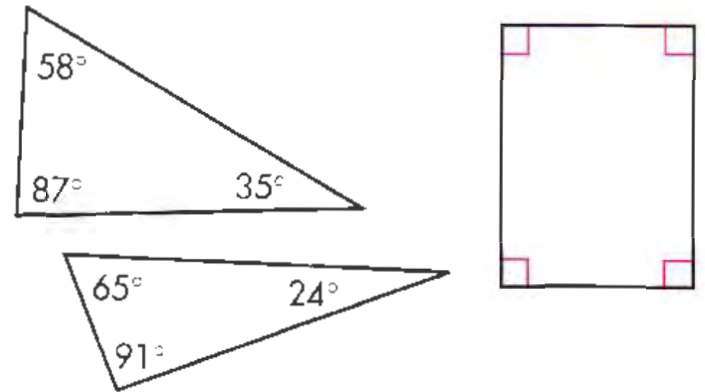

2. Define *acute triangle*.

Acute triangles

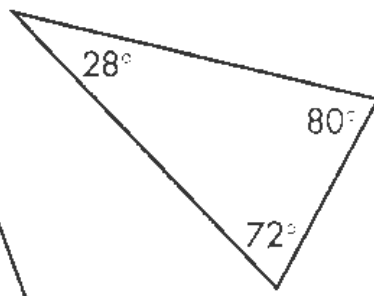
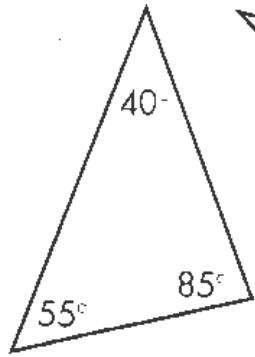
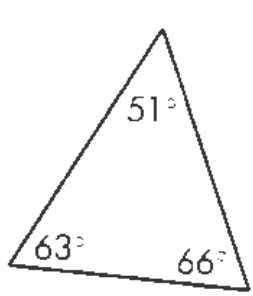

Not acute triangles

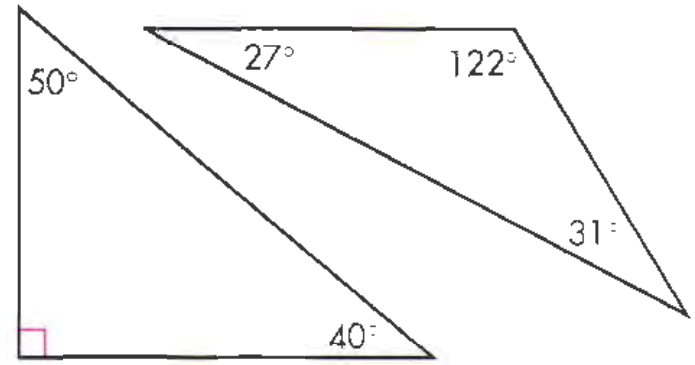

3. Define *obtuse triangle*.

Obtuse triangles

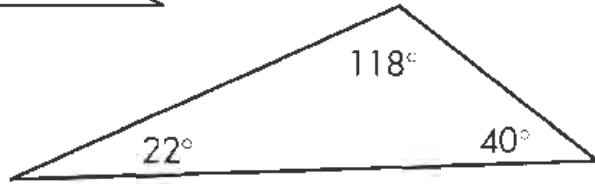
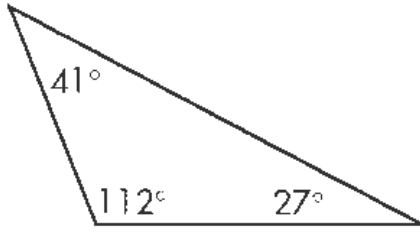

Not obtuse triangles

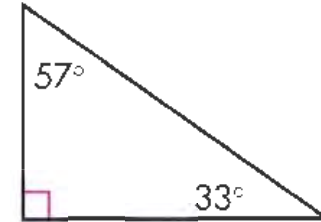
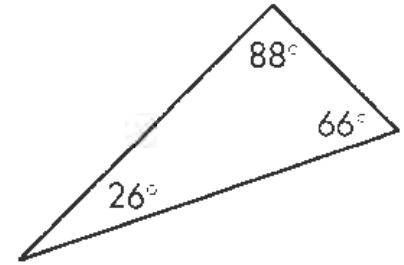
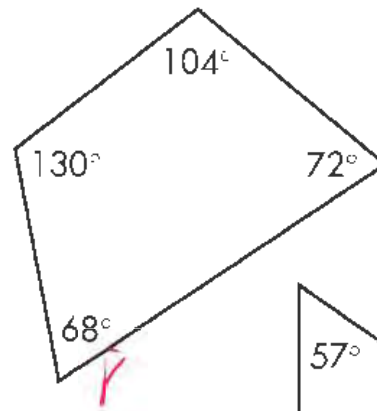

4. Define *scalene triangle*.

Scalene triangles

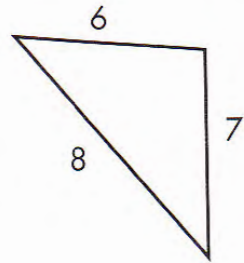
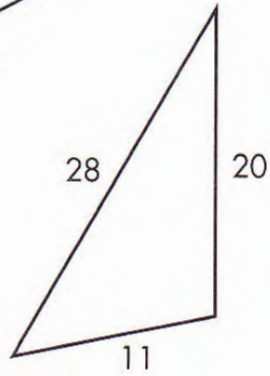
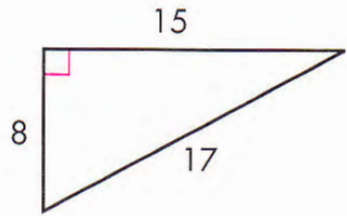

Not scalene triangles

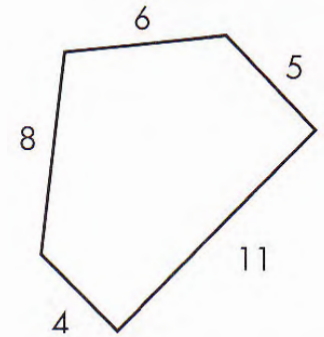
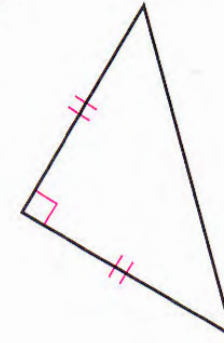
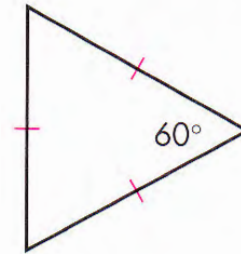

5. Define *isosceles triangle*.

Isosceles triangles

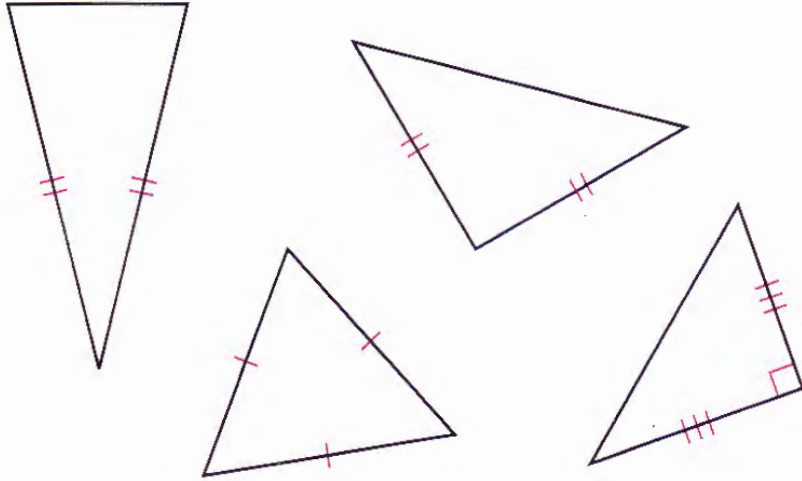

Not isosceles triangles

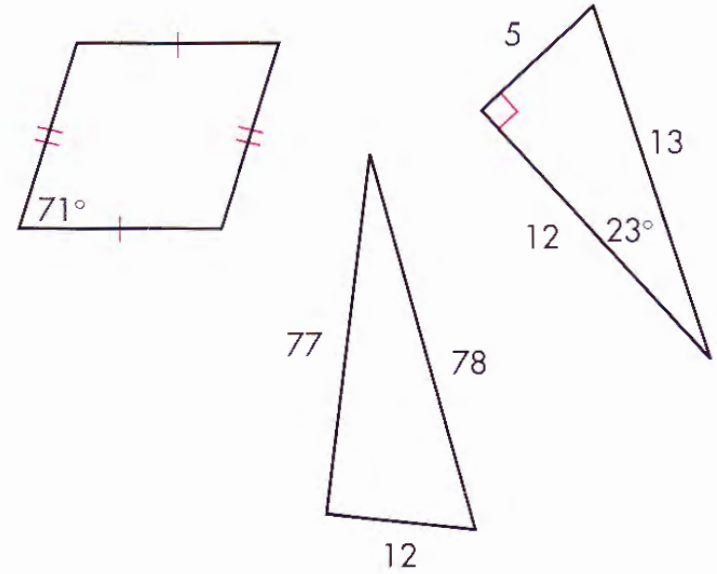

6. Define *median of a triangle*.

Medians of triangles

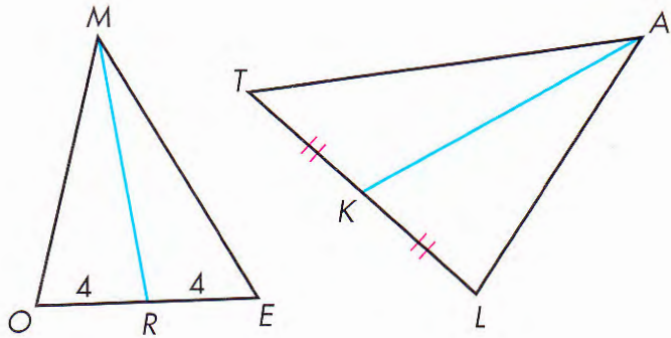

Segments MR and AK are medians.

Not medians of triangles

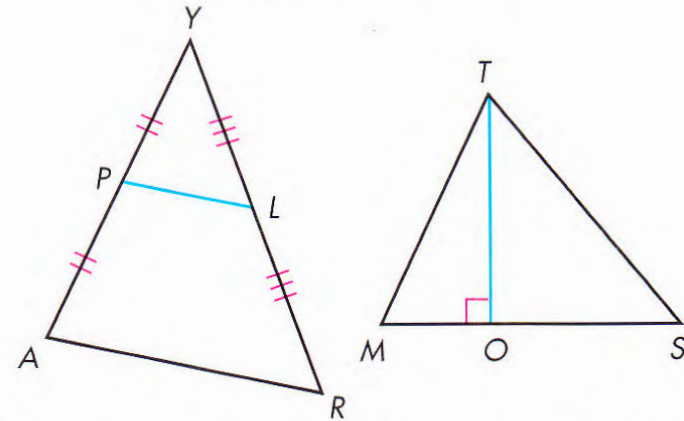

Segments PL and TO are not medians.

7. Define *altitude of a triangle*.

Altitudes of triangles

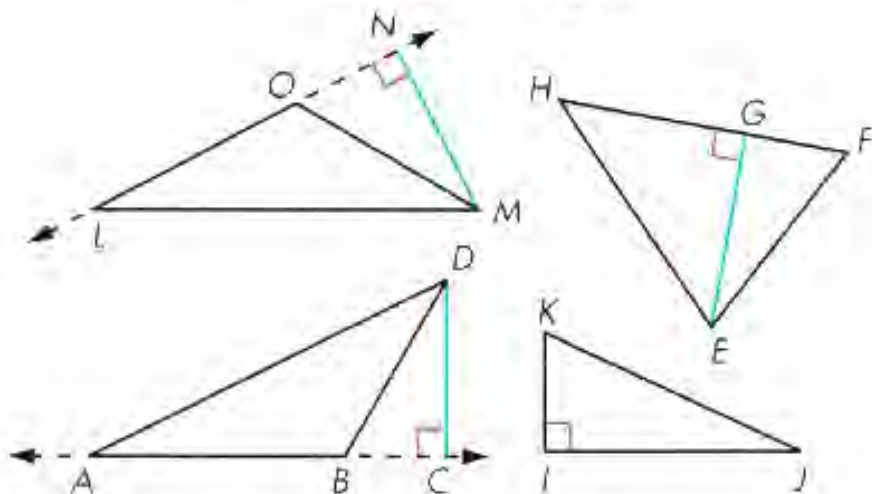

Segments MN , EG , CD , and IK are altitudes.

Not altitudes of triangles

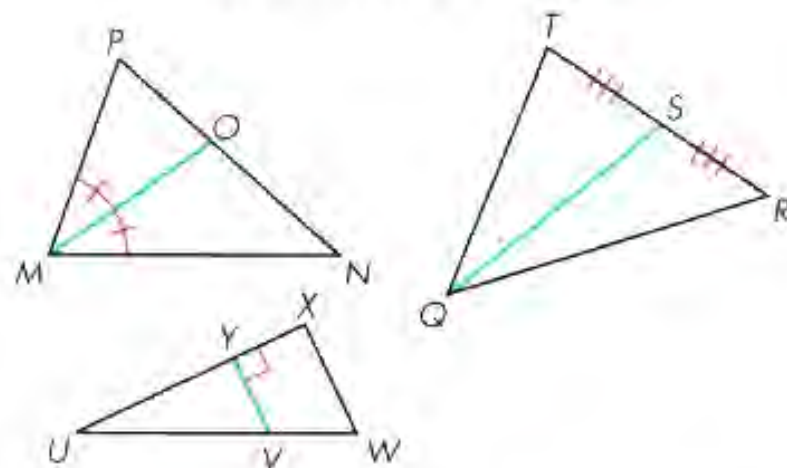

Segments MO , QS , and YV are not altitudes.